



SDM230-DR

Single-Phase Two Module DIN rail Meters



- Measure Total Energy
- Two pulse outputs
- Din rail mounting 35mm
- 100A direct connection
- Better than Class 1 / B accuracy

User Manual V1.0

2015

Application

The energy-meters “with a blue back-lighted LCD screen for perfect reading” are used to measure single-phase like residential, Utility and Industrial application. The unit measures and displays various important electrical parameters.

PART 1 Specification**General Specifications**

Voltage AC (Un)	230V
Voltage Range	176~276V AC
Base Current (Ib)	10A
Max. Current (Imax)	100A
Mini Current (Imin)	0.5A
Starting current	0.4% of Ib
Power consumption	<2W/10VA
Frequency	50Hz(±10%)
AC voltage withstand	4KV for 1 minute
Impulse voltage withstand	6KV-1.2uS waveform
Overcurrent withstand	30Imax for 0.01s
Pulse output rate	1000imp/kWh (Import) 1000imp/kWh (Export)
Display	LCD with blue backlit
Max. Reading	999999.9kWh

Accuracy

Active energy	Class 1 IEC62053-21
---------------	---------------------

Environment

Operating temperature	-25°C to +55°C
Storage and transportation temperature	-40°C to +70°C
Reference temperature	23°C ± 2°C
Relative humidity	0 to 95%, non-condensing
Altitude	up to 2500m
Warm up time	10s
Installation category	CAT III
Mechanical Environment	M1
Electromagnetic environment	E2
Degree of pollution	2

Output

Pulse Output

The meter provides two pulse outputs. Both pulse outputs are passive type.

Pulse 1: Export active energy, constant 1000imp/KWh, pulse width 100ms, non-configurable

Pulse 2: Import active energy, constant 1000imp/KWh, pulse width 100ms, non-configurable

Mechanics

Din rail dimensions	36x99x63 (WxHxD) DIN 43880
Mounting	DIN rail 35mm
Sealing	IP51 (indoor)
Material	self-extinguishing UL94V-0

LCD display

Item	Descriptions
1	7 digits used to display measured values or RTC
2	Total value
4	Import information, Export information
5	Max. Demand for Power or Current
6	Pulse output 1 and Pulse output 2
7	Measurement units
8	PF = power factor Hz = frequency
9	Bar display of Power
10	Communication indicator
11	Time information
12	Low battery warning
13	Lock symbol

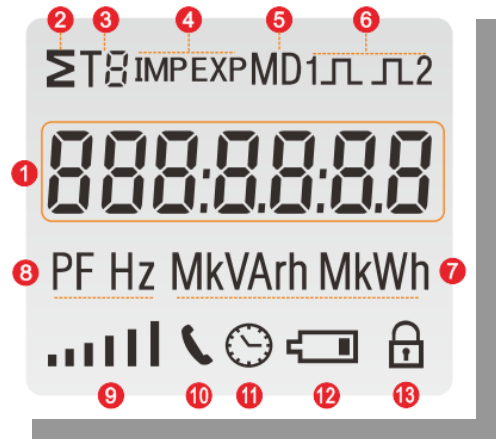

PART 2 Operation

Initialization Display

When it is powered on, the meter will initialize and do self-checking.

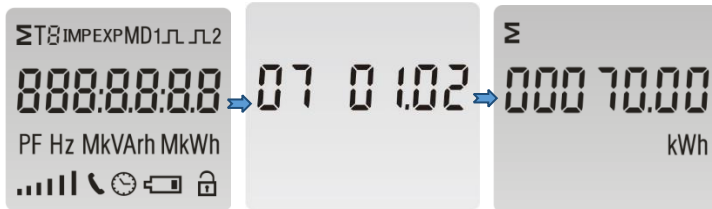

Full screen → software version → total kWh



Scroll display by Button

After initialization and self-checking program, the meter display the measured values. The default page is total kWh. If the user wants to check other information, he needs to press the scroll button on the front panel.



The display order by scroll button:

Total kWh → resettable kWh → W.

Page	Display	Descriptions
1		Total active energy Example:70.00kWh
2		Total resettable energy
3		Active Power Example: 4700W

Long press button  for 3 S, clear the resettable energy

Wiring diagram

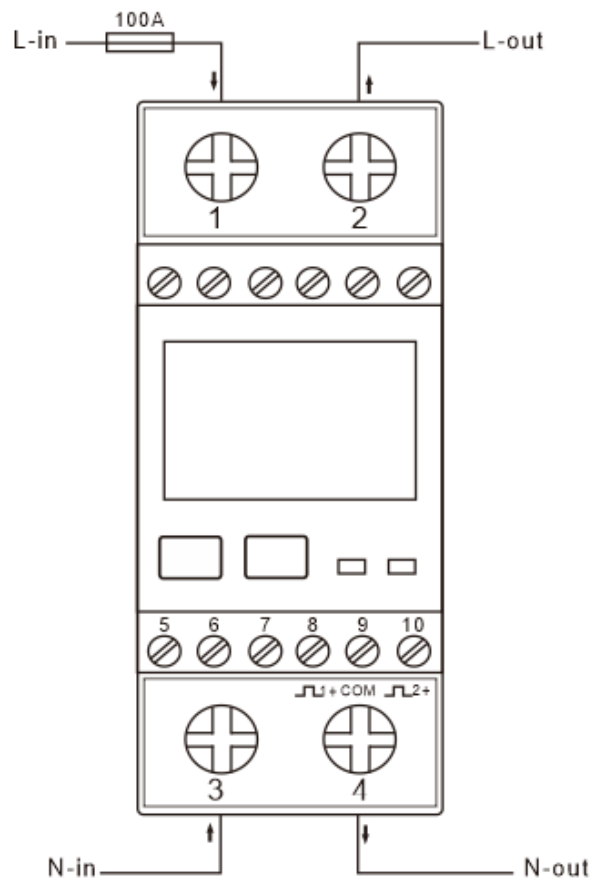

Dimensions

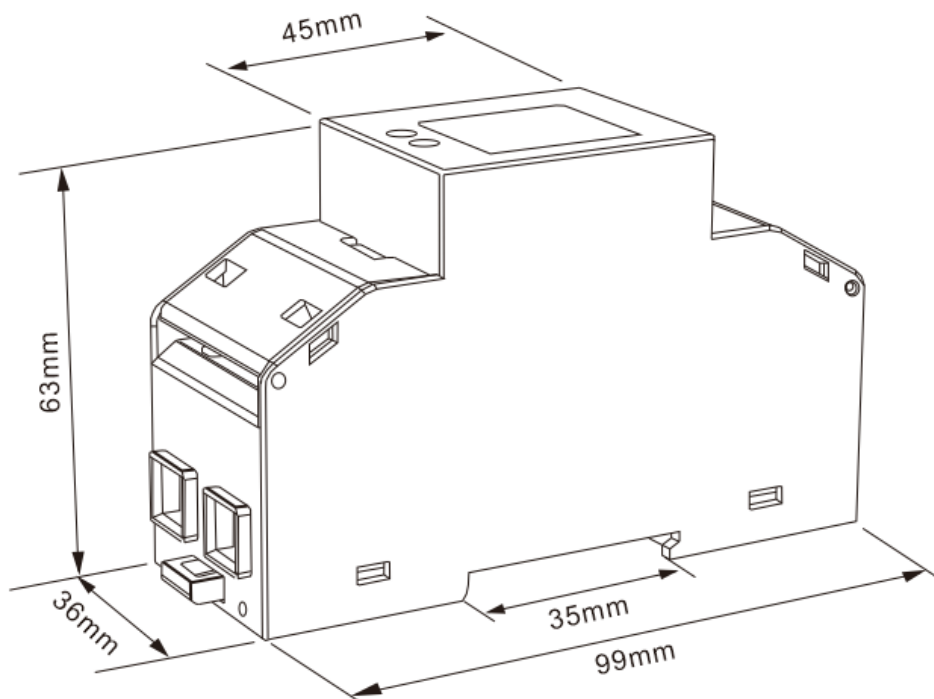

Installation

